



VERONICA
CERAMIC

VERONICA
CERAMIC

**Q
U
A
R
T
Z**

KITCHEN SINK

Elevate
Your Kitchen
Experience with Quartz
Elegance

VERONICA

CERAMIC

MULTI FUNCTIONAL QUARTZ SINK



SINGLE BOWL SINK

SPECIFICATION
SIZE : 30 X 20 X 9 inch
MM : 760 X 510 X 230 mm

WEIGHT
22.5 Kg. (Approx) WITH BOX

THICKNESS
12 MM

M.R.P.
Granite : 21000/-
Metallic : 22500/-

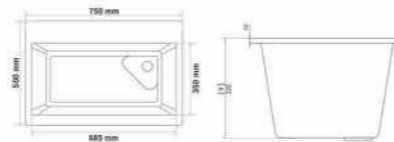

Quartz kitchen sinks are typically composed of a combination of quartz stone and acrylic resins. The quartz particles provide durability, strength, and resistance to scratches and stains, while the acrylic resins bind everything together,

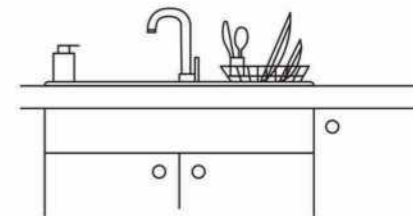

VERONICA
CERAMIC

**MUL
TIFUN
CTIONAL
SINK**
—
30x18x9



CHOPPING BOARD



SQUARE SINK COUPLING



COLANDER BASKET



HANDMADE SINK



GLASS WASHER



COLANDER TRAY



WASTE PIPE DRAINER



SINK FAUCET



CONNECTION PIPES



RO FILTER TAP



LIQUID DISPENSER

VERONICA

CERAMIC

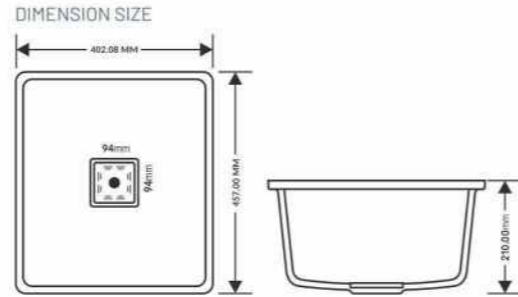
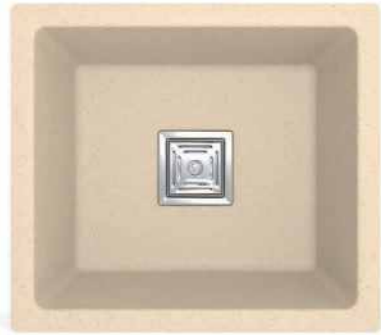

SPECIFICATION

SIZE : 16 X 18 X 8 inch
MM : 402 X 457 X 210 mm

WEIGHT
7.8 Kg. (Approx)

M.R.P.
Granite : 4700/-
Metallic : 5100/-

10 MM
THICKNESS

SINGLE BOWL SINK

METALLIC SERIES



GRANITE SERIES



Quartz kitchen sinks are typically composed of a combination of quartz stone and acrylic resins. The quartz particles provide durability, strength, and resistance to scratches and stains, while the acrylic resins bind everything together,

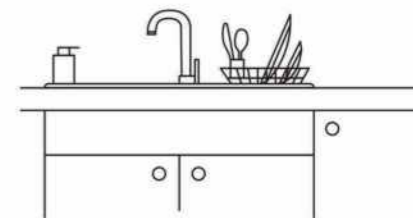

VERONICA

CERAMIC

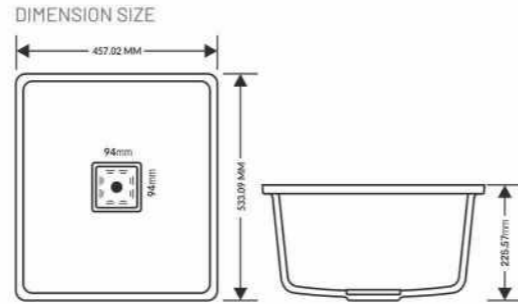
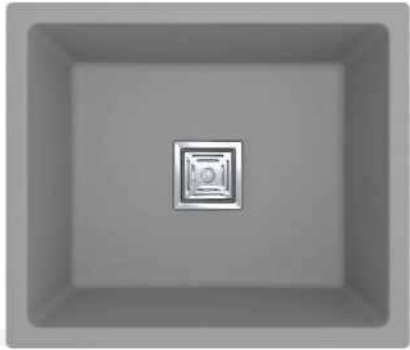

SPECIFICATION

SIZE : 21 X 18 X 9 inch
MM : 457 X 533 X 225 mm

WEIGHT
10.1 Kg. (Approx)

M.R.P.
Granite : 5200/-
Metallic : 6100/-



SINGLE BOWL SINK

METALLIC SERIES



GRANITE SERIES



Quartz kitchen sinks are typically composed of a combination of quartz stone and acrylic resins. The quartz particles provide durability, strength, and resistance to scratches and stains, while the acrylic resins bind everything together,

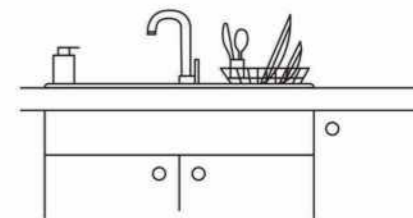

VERONICA

CERAMIC

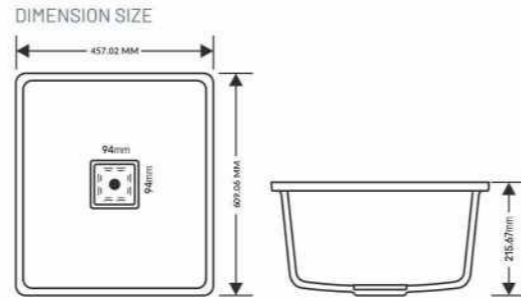

SPECIFICATION

SIZE : 24 X 18 X 9 inch
 MM : 609 X 457 X 215 mm

WEIGHT
 11.5 Kg. (Approx)

M.R.P.
 Granite : 5900/-
 Metallic : 6800/-



SINGLE BOWL SINK

METALLIC SERIES



GRANITE SERIES



Quartz kitchen sinks are typically composed of a combination of quartz stone and acrylic resins. The quartz particles provide durability, strength, and resistance to scratches and stains, while the acrylic resins bind everything together,

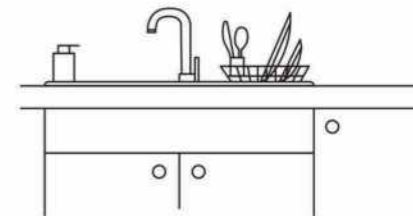

VERONICA

CERAMIC



DIMENSION SIZE

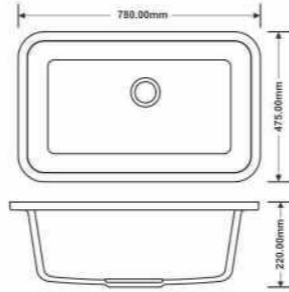

SPECIFICATION

SIZE : 31 X 19 X 9 inch
 MM : 780 X 475 X 220 mm

WEIGHT

14 Kg. (Approx)

M.R.P.

Granite : 8100/-
 Metallic : 9350/-



SINGLE BOWL SINK

METALLIC SERIES



GRANITE SERIES



Quartz kitchen sinks are typically composed of a combination of quartz stone and acrylic resins. The quartz particles provide durability, strength, and resistance to scratches and stains, while the acrylic resins bind everything together,

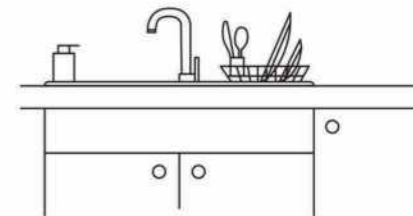

VERONICA

CERAMIC

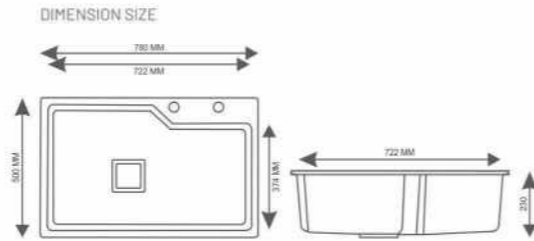
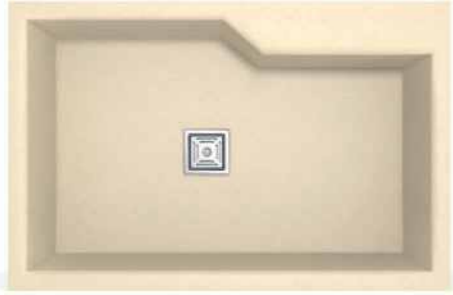

SPECIFICATION

SIZE : 30 X 20 X 9 inch
MM : 500 X 780 X 230 mm

WEIGHT

16 Kg. (Approx)

M.R.P.

Granite : 8700/-
Metallic : 10100/-



SINGLE BOWL SINK

METALLIC SERIES



GRANITE SERIES



Quartz kitchen sinks are typically composed of a combination of quartz stone and acrylic resins. The quartz particles provide durability, strength, and resistance to scratches and stains, while the acrylic resins bind everything together,

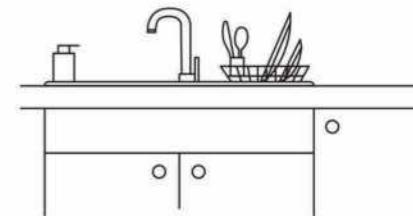

VERONICA

CERAMIC

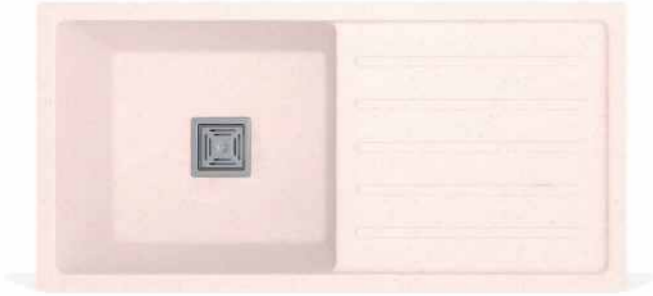

DIMENSION SIZE

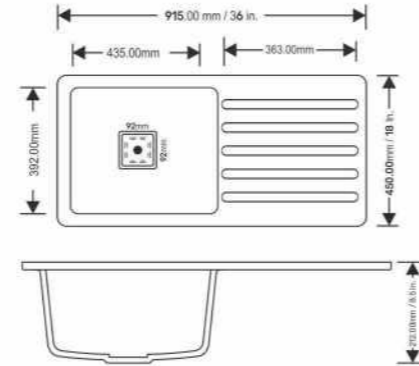

SPECIFICATION

SIZE : 36 X 18 X 8.5 inch
MM : 915 X 457 X 212 mm

WEIGHT
15 Kg. (Approx)

M.R.P.
Granite : 9600/-
Metallic : 11400/-



SINGLE BOWL WITH DRAIN BOARD SINK



METALLIC SERIES



GRANITE SERIES



Quartz kitchen sinks are typically composed of a combination of quartz stone and acrylic resins. The quartz particles provide durability, strength, and resistance to scratches and stains, while the acrylic resins bind everything together,

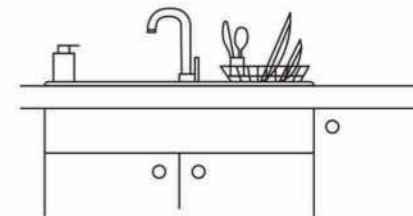

VERONICA

CERAMIC



DIMENSION SIZE

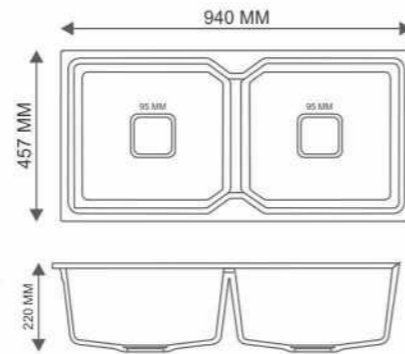

SPECIFICATION

SIZE : 37 X 18 X 9 inch
 MM : 940 X 457 X 220 mm

WEIGHT
 22.5 Kg. (Approx)

M.R.P.
 Granite : 11200/-
 Metallic : 12900/-



DOUBLE BOWL SINK

METALLIC SERIES



GRANITE SERIES



Quartz kitchen sinks are typically composed of a combination of quartz stone and acrylic resins. The quartz particles provide durability, strength, and resistance to scratches and stains, while the acrylic resins bind everything together,

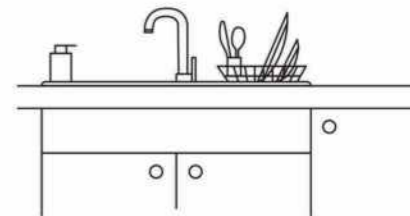

VERONICA

CERAMIC

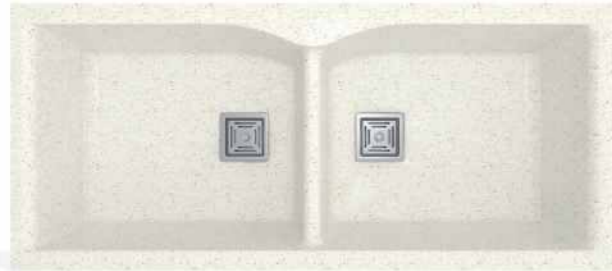

DIMENSION SIZE

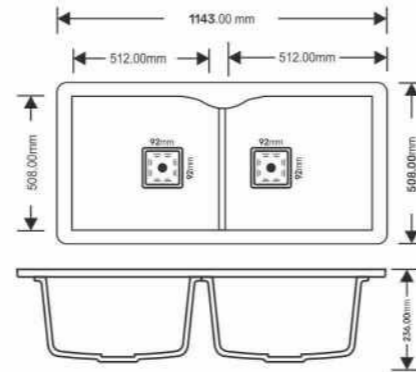

SPECIFICATION

SIZE : 45 X 20 X 9 inch
MM : 1143 X 508 X 226 mm

WEIGHT
25 Kg. (Approx)

M.R.P.
Granite : 20500/-
Metallic : 21600/-



DOUBLE BOWL SINK

METALLIC SERIES



GRANITE SERIES



Quartz kitchen sinks are typically composed of a combination of quartz stone and acrylic resins. The quartz particles provide durability, strength, and resistance to scratches and stains, while the acrylic resins bind everything together,

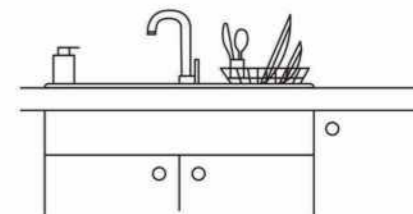

AVAI
LABLE
COL
ORS

METALLIC SERIES



BLACK



GREY



BROWN



WHITE

GRANITE SERIES



GREY STONE



SNOW WHITE



IVORY



PEACH



CREAM STONE

Features of Quartz Kitchen Sink



Easy to Clean



Stain Resistant



Ever Lasting



Hygienic



Heat Resistant



Range of Colors



Certified Quality



High Durability



Reversible



Shine Lock Technology



Installation



TOP MOUNT



UNDER MOUNT



FLUSH MOUNT

Disclaimer

- Product shown here is only for demonstration purpose, actual product may vary from the product as shown in the catalogue.
- Specification of the product may change without any prior intimation.
- All the test/performance are according to standard condition.
- Colour shown is representative colour and may vary from the actual product.
- All size are approx.

OUR OTHER PRODUCTS

HANDMADE SINK | MARBLE TABLE TOP
SHOWER PANEL | SHOWER SET | IMPORTED BASIN